

# X3-Timing

V 1.1 6/23/21

## Precision Sampling Rate Generation and Triggering Controls with GPS and High Precision Reference

### FEATURES

- Clock generation and distribution
- Four single-ended clock outputs
- External clock/reference input
- Low noise: 0.3 ps jitter RMS, -115 dB phase noise @ 10kHz (fc=491.5MHz)
- Programmable 1.5 kHz to 1 GHz range
- 10 MHz, 0.28 or 1ppm frequency reference
- Four programmable trigger outputs
- Supports PXI DSTAR, DCLKA, DCLKB, triggers and local bus
- External trigger input
- Instant-on configuration
- XMC Module (75x150 mm)
- PCI Express (VITA 42.3)

### APPLICATIONS

- Sample clock generation for high speed data acquisition applications
- Sample clock generation for multi-channel systems
- Synchronization for distributed systems
- Timing Generation

### SOFTWARE

- Windows/Linux Drivers
- C++ Host Tools

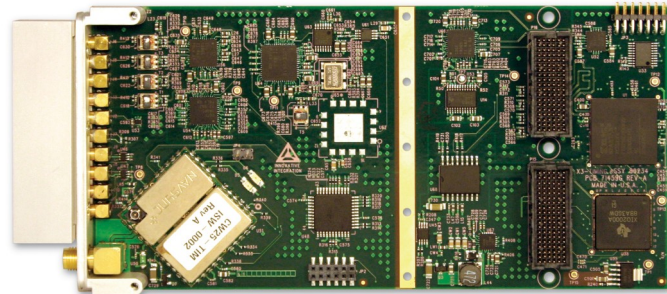

### DESCRIPTION

The X3-Timing is an XMC I/O module with precision, low-noise clock generation and distribution for data acquisition and communications timing applications. The module has four output clocks and four output triggers as well as a clock/reference input and a trigger input. The X3-Timing can also act as a system timing card in PXI systems, providing the reference clock, sample clocks and triggering.

In the sample clock generation mode, the X3-Timing can generate clocks from 1560 kHz to 1 GHz. The clocks are referenced to an on-card 0.28 or 1 ppm oscillator, or an external input. The PLL circuit is fully programmable, providing extremely low noise clocks with 0.3 ps RMS jitter (-115dB phase noise at 10 kHz). The output clocks are phase aligned to within 100 ps. Each output clock is a 1 to 80 subdivision of the PLL or external clock.

A Windows and Linux application are provided that are used to configure and control the X3-Timing features. Configurations can be stored for instant-on use in the on-card memory.

Software tools for host development include C++ libraries and drivers for Windows and Linux.

 Please be aware that an important notice concerning availability, standard warranty, and use in critical applications of Interconnect Systems International, LLC, Inc. products and disclaimers thereto appears at the end of this data sheet. All trademarks are the property of their respective owners.

PRODUCTION DATA information is current as of publication date. Products conform to specifications per the terms of the Interconnect Systems International, LLC, Inc. standard warranty. Production processing does not necessarily include testing of all parameters.

# X3-Timing



This electronics assembly can be damaged by ESD. ISI Interconnect Systems International, LLC, Inc recommends that all electronic assemblies and components circuits be handled with appropriate precautions. Failure to observe proper handling and installation procedures can cause damage. ESD damage can range from subtle performance degradation to complete device failure. Precision integrated circuits may be more susceptible to damage because very SSMCII parametric changes could cause the device not to meet its published specifications.

## ORDERING INFORMATION

Product	Part Number	Description
X3-Timing	80234-0	PCI Express XMC module with four clock outputs, four trigger outputs, external trigger and clock inputs, PXI clock support and 280 ppb reference.
X3-Timing	80234-4	X3-Timing, 1 ppm crystal, no GPS, LVCMOS outputs
<b>Cables</b>		
MMCX to BNC cable	67069	MMCX to BNC male coax cable, 1m
<b>Adapters</b>		
XMC-PCIe X8 ADAPTER	80363-2-L0 80363-3-L0	PCI Express carrier board for XMC modules, x8 lanes, Onboard USB JTAG, Robust Thermal Solution, Voltage Monitor, 8 high quality Differential DIO pairs, High speed expansion port (QSFP)  XMC-PCIe X8 ADAPTER XMC INT PWR XMC-PCIe X8 ADAPTER XMC INT PWR
XMC-PXIE Adapter	80341-2-L0	PXIE carrier carrier board for XMC modules, x8 lanes, 8 High Speed gigabit transceiver (QSFP), 8 high quality Differential DIO pairs  XMC-PXIE Adapter X3 3U 8HP
XMC-PCIe x1 Adapter	80172-0	PCI Express carrier board for XMC modules, x1 lanes, 38 General Purpose Differential DIO, SMB RF Jacks (REF CLK, SAMPLE CLK, TRIGGER 0, TRIGGER 1)  PCI Express Carrier card for XMC PCI Express modules, x1 lanes
XMC-Cabled PCIe Adapter	90181-0	Cabled PCI Express Carrier card for XMC PCI Express modules, single-lane.  XMC TO CABLED PCI EXPRESS CARRIER PLUS ENCLOSURE
XMCE CPCI ADAPTER (PXI)	80207-0	XMCE CPCI ADAPTER, x4 Lane, x26 General Purpose DIO
<b>Embedded PC Host</b>		
ePC-Duo	90602 See datasheet for options	ePC-Duo: Carrier Board for x2 XMC module, x8 lane, Skylake Processor, 32GB RAM, x1 1 Gbe, x2 10 Gbe, x4 mSATA, IEEE or GPS optional, x2 QSFP ports, Onboard USB JTAG (XMC module must have JTAG signals on P16 XMC connector), onboard voltage monitor, x10 high quality XMC module DIO pairs from each XMC module, convection-cooled chassis, 150W power supply

# X3-Timing

SBC-Nano	90659  <i>SBC-Nano See datasheet for options</i>	SBC-Nano: Carrier Board for x1 XMC module, COM Express Type 10 ATOM, 8 GB DDR3L memory, x4 lanes PCIe, x2 mSATA, x1 Gbe, Conduction or Convection cooled chassis
<i>VPXI-ePC</i>	90271-0	VPXI System – 3U VPX embedded PC system with 4 expansion slots; runs Windows, Linux, or VxWorks; Intel i7 CPU, integrated timing support backplane

# X3-Timing

X3-Timing Block Diagram

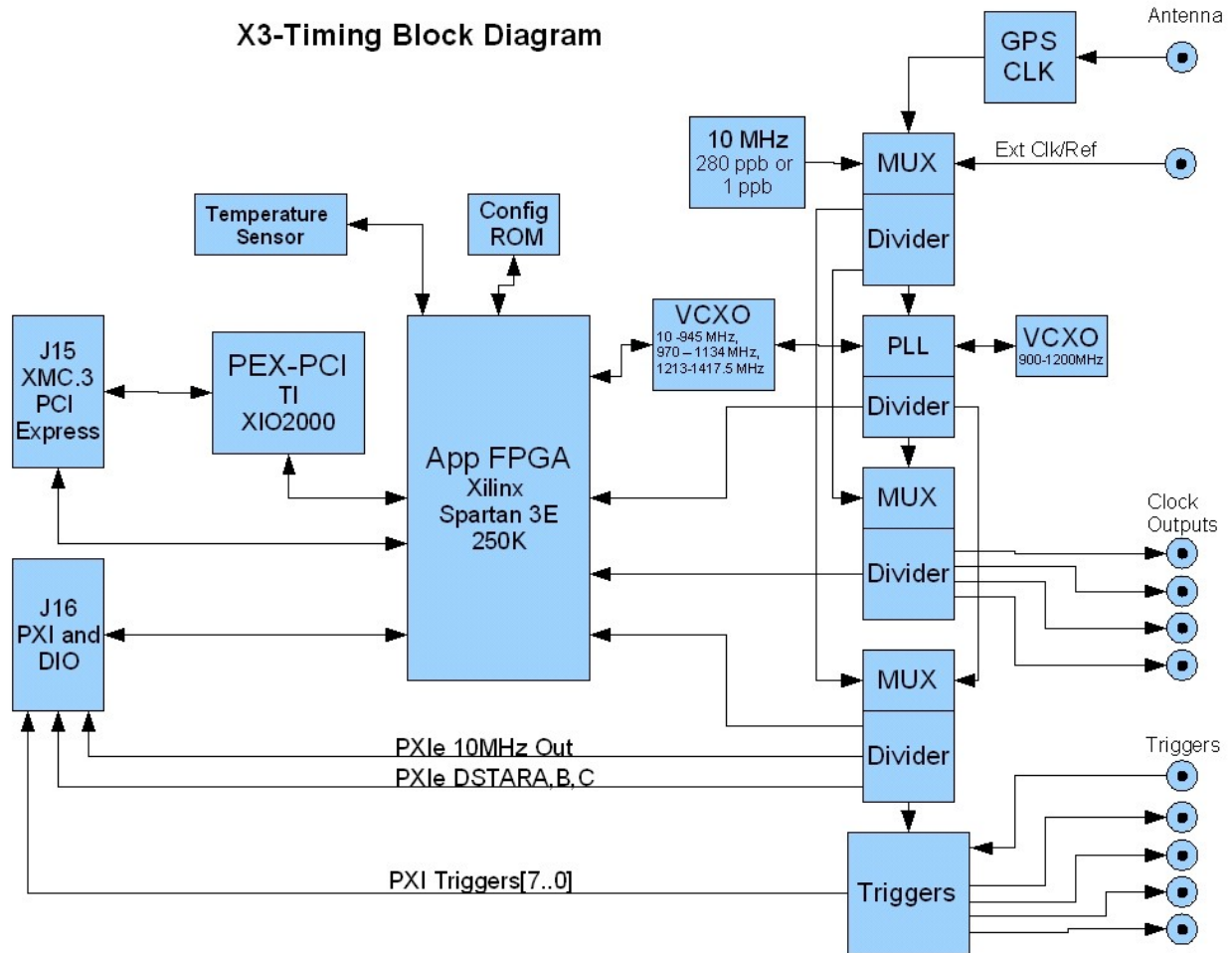

# X3-Timing

## Standard Features

Clock Generation	
Clock Sources	Programmable PLL: TI CDCE72010
	External: Sine/square input
PLL References	Programmable to select either 10 MHz oscillator (see specs below), or external input
PLL Frequency Range	1.56kHz to 1 GHz
PLL Tuning Resolution	<1 kHz

Reference	
Frequency	10 MHz
Stability	1 ppm
Accuracy	Calibrated to 1 ppm
Noise	-120 dBc/Hz @ 10 MHz offset

Clock/Reference Input	
Inputs	1
Input Range	0.5-3.3Vp-p (-2 to +14.3 dBm), Vcm=1.2 to 3.0VDC, sine or square wave
Input Type	Single ended, AC coupled
Input Impedance	50 ohm
Input Frequency Range	1kHz to 500 MHz
Routing	Clock or PLL Reference
Connector	MMCX female

Clock Outputs	
Outputs	4
Output Range	850 mVp-p, min for 50 ohm load
Output Type	Single ended, DC coupled
Output Impedance	50 ohm
Connectors	MMCX female

Triggers	
Modes	Continuous or N-point frame
Sources	Software, external
Output trigger rate	250 MHz max
Frame Sizes	4 to 16M points
Inputs	1 external, 3.3V LVTTTL, 1K input impedance, DC-coupled, MMCX
Input trigger level	Min high: 2.0V; Max low: 0.8V
Input trigger rise/fall time	20 ns max
Outputs	4, 3.3V LVTTTL, 50 ohm output impedance, DC-coupled, MMCX
Output level	Min high: 3.1V (unloaded); Max low: 0.2V (unloaded)
Output current	Source: 35mA typical (2.5V out); Sink: 8 mA typical (0.4V out)
Output rise/fall time	< 5 ns typical, depending on loading

# X3-Timing

<b>PXI Features</b>	
PXI Clocks	PXI STAR A,B,C PXI Clock
PXI Reference Output	1 ppm reference
PXI Triggers	8
PXI	LVTTTL (3.3V)
Drive	+/-12 mA
Connector	XMC P16

<b>ABSOLUTE MAXIMUM RATINGS</b>				
Exposure to conditions exceeding these ratings may cause damage!				
Parameter	Min	Max	Units	Conditions
Supply Voltage, 3.3V to GND	+3.0	+3.6	V	
Clkin/Trigger Input Voltage	-5.7	+5.7	V	DC Coupled
Operating Temperature	0	70	C	Non-condensing, forced air cooling required
Storage Temperature	-65	+150	C	
ESD Rating	-	1k	V	Human Body Model
Vibration	-	5	g	9-200 Hz, Class 3.3 per ETSI EN 300 019-1-3 V2.1.2 (2003-04)
Shock	-	40	g peak	Class 3.3 per ETSI EN 300 019-1-3 V2.1.2 (2003-04)
<b>RECOMMENDED OPERATING CONDITIONS</b>				
Parameter	Min	Typ	Max	Units
Supply Voltage	+3.15	+3.3	+3.45	V
Operating Temperature	0		60	C

# X3-Timing

## RECOMMENDED OPERATING CONDITIONS

### ELECTRICAL CHARACTERISTICS

Over recommended operating free-air temperature range at 0°C to +60°C, unless otherwise noted.

Parameter	Typ	Units	Notes
Output Frequency Range	0.1 to 1000	MHz	
Clock Jitter	310	fs	Target specification with output filter
Accuracy	1	ppm	After calibration
Stability	1	ppm	
Power Consumption	5.8	W	1.76A from 3.3V with 4 outputs @ 400 MHz

# X3-Timing

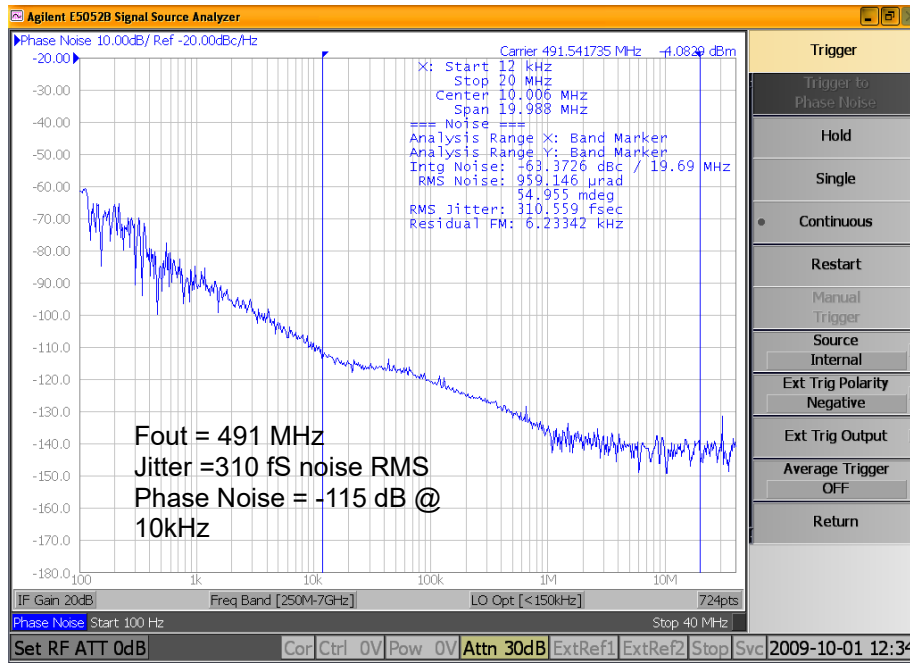

X3-Timing Phase Noise for  $F_c=491.541735$  MHz, -4 dBm output using 10MHz Reference Clock



# X3-Timing

## Architecture and Features

The X3-Timing module is a PCI Express XMC module designed to support high speed digitizing systems with multiple channels. The card provides extremely low noise clock signals that are required for accurate digitizing of high speed analog signals in systems such as RF/IF front ends, RADAR systems and high speed pulse digitizing.

### Clock Generation

The X3-Timing features a flexible sample rate generation architecture built around a PLL with tunable VCXO. The PLL and VCXO are fully programmable with an output range from 100 kHz to 1 GHz.

The PLL reference inputs are also software programmable and provide selection between a 10 MHz reference oscillator and an external input. The reference oscillator has 1 ppm stability rating. The references may be divided before the PLL by values from 1 to 80 (not all numbers inclusive) so that high frequency external inputs can be used.

### Clock Outputs

There are four clock outputs on the front panel and four PXI clocks. All clock outputs may be synchronous or individually subdivided from the PLL or external clock, or the reference clock.

### Triggering

The X3-Timing has four trigger outputs to the front panel and an additional 8 triggers for PXI. The triggers are programmable for framed mode, used for data snapshots, or continuous mode. The trigger can be fired from software or external input. All trigger outputs are synchronous.

<b>Trigger Mode</b>	Continuous	<i>Trigger is true on next rising edge of the sample clock until source is deasserted</i>
	Framed	<i>Once fired, the trigger is true for N data points</i>

### PXI Support

The X3-Timing can act as a PXI system timing card when used with the PXI adapter (80207). PXI clock outputs for the system STAR clocks are sourced from the PLL or external clock input through a separate clock divider/buffer device. These clocks may be the PLL, external clock, or subdivisions of these.

The PXI 10 MHz system reference may also be driven by the on-card reference to provide higher stability. (Requires 80207 Rev B or higher). PXI signals use J16 to connect with the PXI adapter card.

The triggering controls also provide eight PXI triggers synchronized to the sample clocks.

### Configuration Storage

The X3-Timing configuration can be saved to on-card FLASH memory for instant-on configuration. After programming, the X3-Timing can be used in a “stand-alone” mode without the computer as an instrument with the eInstrument Node DAQ. The configuration can always be updated using the software by reconnecting to the computer.

### Software Tools

The X3-Timing can be easily configured using the configuration program. The application provides a control panel interface for configuring the PLL and clock distribution features including reference source, output frequency, triggering modes, and PXI timing. No programming is necessary for most applications. Configurations may be saved for instant recall, or stored and recalled later.

# X3-Timing

Software development tools for the X3-Timing provides comprehensive support including device drivers, card controls, and utilities that allow developers to be productive from the start. Software classes provide C++ developers a powerful, high-level interface to the card making the X3-Timing easier to integrate into applications.

Support for MS Visual C++ is provided. Supported OS include Windows and Linux. For more information, the software tools User Guide and on-line help may be downloaded.

## Applications Information





### Cables

The X3-Timing module uses coaxial cable assemblies for the IO. The mating cables have an MMCX male connector and 50 ohm characteristic impedance for best signal quality.

### XMC Adapter Cards

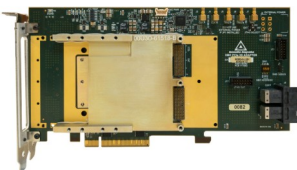
XMC modules can be used in standard desktop system or compact PCI/PXI using a XMC adapter card. An auxiliary power connector to the PCI Express adapters provides additional power capability for XMC modules when the slot is unable to provide sufficient power. The adapter cards allow the XMC modules to be used in any PCIe or PCI system.

The X3-Timing uses the auxiliary P16 connector to interface to provide additional triggers and clocks for PXI. When the X3-Timing card is used with the cPCI/PXI adapter (80208), the card may act as a system timing controller. The 10MHz system reference clock is replaced by the X3-Timing reference.

<p><b>XMC-PCIe X8 ADAPTER</b> (80363-2,3)</p>  <p><b>XMC-Cabled PCIe ADAPTER</b> (90181-0)</p> 	<p><b>XMC-PXIE ADAPTER</b> (80341-2)</p> 	<p><b>XMC-PCIe x1 ADAPTER</b> (80172-0)</p> 	<p><b>Compact PCI-XMC Adapter</b> (80207-0)</p> 
---	--	--	---

Applications that need remote or portable IO can use either the eInstrument PC or eInstrument Node with X3 modules.

# X3-Timing

EPC-DUO (90602)



SBC-NANO (90659)



VPXI-ePC (90271-0)



**VPXI-ePC**

# X3-Timing

## IMPORTANT NOTICES

Interconnect Systems International, LLC reserves the right to make corrections, modifications, enhancements, improvements, and other changes to its products and services at any time and to discontinue any product or service without notice. Customers should obtain the latest relevant information before placing orders and should verify that such information is current and complete. All products are sold subject to Interconnect Systems International, LLC 's terms and conditions of sale supplied at the time of order acknowledgment.

Interconnect Systems International, LLC warrants performance of its hardware products to the specifications applicable at the time of sale in accordance with Interconnect Systems International, LLC 's standard warranty. Testing and other quality control techniques are used to the extent Interconnect Systems International, LLC deems necessary to support this warranty. Except where mandated by government requirements, testing of all parameters of each product is not necessarily performed.

Interconnect Systems International, LLC assumes no liability for applications assistance or customer product design. Customers are responsible for their products and applications using Interconnect Systems International, LLC products. To minimize the risks associated with customer products and applications, customers should provide adequate design and operating safeguards.

Interconnect Systems International, LLC does not warrant or represent that any license, either express or implied, is granted under any Interconnect Systems International, LLC patent right, copyright, mask work right, or other Interconnect Systems International, LLC intellectual property right relating to any combination, machine, or process in which Interconnect Systems International, LLC products or services are used. Information published by Interconnect Systems International, LLC regarding third-party products or services does not constitute a license from Interconnect Systems International, LLC to use such products or services or a warranty or endorsement thereof. Use of such information may require a license from a third party under the patents or other intellectual property of the third party, or a license from Interconnect Systems International, LLC under the patents or other intellectual property of Interconnect Systems International, LLC .

Reproduction of information in Interconnect Systems International, LLC data sheets is permissible only if reproduction is without alteration and is accompanied by all associated warranties, conditions, limitations, and notices. Reproduction of this information with alteration is an unfair and deceptive business practice.

Interconnect Systems International, LLC is not responsible or liable for such altered documentation. Resale of Interconnect Systems International, LLC products or services with statements different from or beyond the parameters stated by Interconnect Systems International, LLC for that product or service voids all express and any implied warranties for the associated Interconnect Systems International, LLC product or service and is an unfair and deceptive business practice. Interconnect Systems International, LLC is not responsible or liable for any such statements.

For further information on Interconnect Systems International, LLC products and support see our web site:

**[www.isipkg.com](http://www.isipkg.com)**

Mailing Address:

Interconnect Systems International, LLC, Inc.

741 Flynn Road, Camarillo, CA 93012