

FMC-250

V 1.02 08/05/14



FMC Module with 2x 250 MSPS 16-bit A/D, 2x 1200 MSPS 16-bit DAC with PLL and Timing Controls

FEATURES

- Two A/D Inputs
 - 250 MSPS, 16-bit option
 - AC or DC coupled
- Two D/A Outputs
 - 1200 MSPS, 16-bit D/A
 - AC or DC coupled
- Sample clocks and timing and controls
 - External clock/reference input
 - Programmable PLL
 - 10 MHz, 0.5 ppm reference
 - Integrated with FMC triggers
- FMC module, VITA 57.1
 - High Pin Count no SERDES required
 - Compatible with 1.2 to 3.3V VADJ
 - Power monitor and controls
- 6W typical (AC-coupled inputs)
- Conduction Cooling per VITA 20 subset
- Environmental ratings for -40 to 85C
9g RMS sine, 0.1g2/Hz random vibration

APPLICATIONS

- Wireless Receiver and Transmitter
- LTE, WiMAX Physical Layer
- RADAR
- Medical Imaging
- High Speed Data Recording and Playback

SOFTWARE

- MATLAB/VHDL FrameWork Logic



DESCRIPTION

The FMC-250 is a high speed digitizing and signal generation FMC IO module featuring two 250SPS A/D channels and two 1200 MSPS D/A channels supported by sample clock and triggering features.

The FMC-250 features two 16-bit 250 MSPS A/Ds, plus a dual channel, 1200 MSPS update rate DAC. Analog IO may be either AC or DC coupled. Receiver IF frequencies of up to 125 MHz are supported. The sample clock is from either an ultra-low-jitter PLL or external input. Multiple cards can be synchronized for sampling.

The FMC-250 power consumption is 9W for typical operation. The module may be conduction cooled using VITA20 standard and a heat spreading plate. Ruggedization levels for wide-temperature operation from -40 to +85C operation and 0.1 g²/Hz vibration. Conformal coating is available.

Support logic in VHDL is provided for integration with FPGA carrier cards. Specific support for Innovative carrier cards includes integration with Framework Logic tools that support VHDL/Verilog and Matlab developers. The Matlab BSP supports real-time hardware-in-the-loop development using the graphical block diagram Simulink environment with Xilinx System Generator for the FMC integrated with the FPGA carrier card.

Software tools for Innovative carrier cards include host development include C++ libraries and drivers for Windows and Linux. Application examples demonstrating the module features are provided.

Please be aware that an important notice concerning availability, standard warranty, and use in critical applications of Innovative Integration products and disclaimers thereto appears at the end of this data sheet. All trademarks are the property of their respective owners.



07/27/15

PRODUCTION DATA information is current as of publication date. Products conform to specifications per the terms of the Innovative Integration standard warranty. Production processing does not necessarily include testing of all parameters.

FMC-250



This electronics assembly can be damaged by ESD. Innovative Integration recommends that all electronic assemblies and components circuits be handled with appropriate precautions. Failure to observe proper handling and installation procedures can cause damage. ESD damage can range from subtle performance degradation to complete device failure. Precision integrated circuits may be more susceptible to damage because very small parametric changes could cause the device not to meet its published specifications.

ORDERING INFORMATION

Product	Part No.	Description
FMC-250	80315-0- <ER>	FMC module with two 250 MSPS 16-bit A/Ds, two 1200 MSPS DACs, PLL and timing controls, DC-coupled A/D and DACs
FMC-250	80315-2- <ER>	Like 80315-0 except ADC and DAC are AC-coupled
Cables		
SSMC to BNC cable	67156	IO cable with SSMC (male) to BNC (male), 1 meter
Carrier Cards		
PEX6-COP	80284	Desktop/server PCI Express FPGA co-processor card with FMC site
Embedded Computer Hosts		
ePC-K7	90502	ePC-K7, I7 CPU, K325T2 Commercial FPGA. Embedded PC with support for two FMC modules; COM Express Type 6 CPU; Windows/Linux drivers
Mini-K7	90600	Mini-K7, Atom CPU, K325T2 Commercial FPGA. Embedded PC with support for one FMC module; COM Express Type 6 CPU; Windows/Linux drivers

FMC-250

FMC-250 Block Diagram

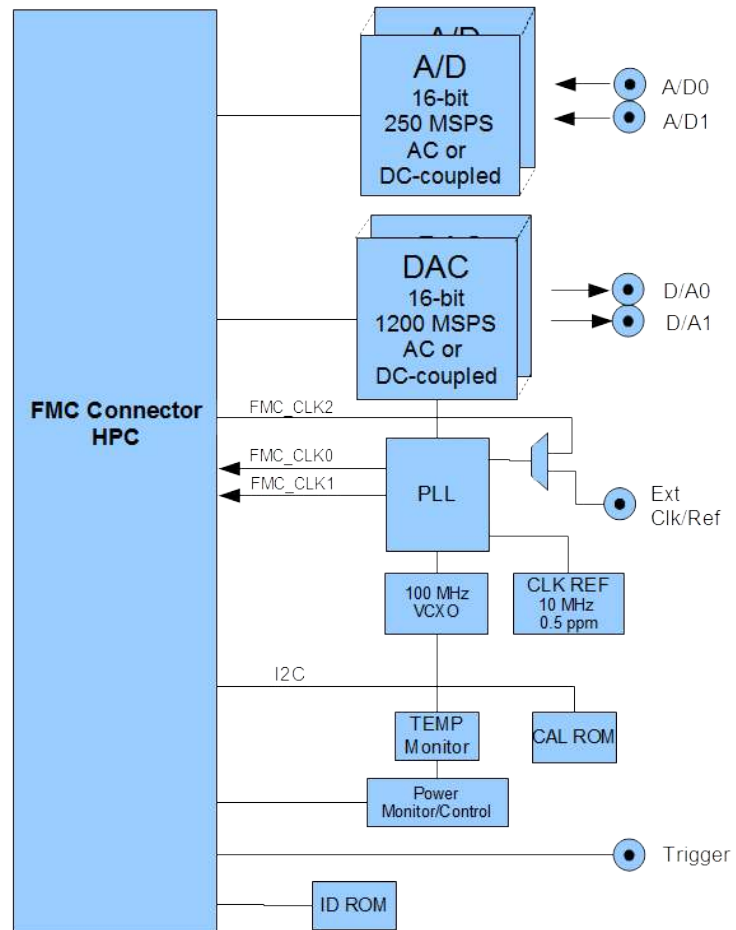

FMC-250

Operating Environment Ratings

Modules rated for operating environment temperature, shock and vibration are offered. The modules are qualified for wide temperature, vibration and shock to suit a variety of applications in each of the environmental ratings L0 through L4 and 100% tested for compliance.

Environment Rating <ER>		L0	L1	L2	L3	L4
Environment		Office, controlled lab	Outdoor, stationary	Industrial	Vehicles	Military and heavy industry
Applications		Lab instruments, research	Outdoor monitoring and controls	Industrial applications with moderate vibration	Manned vehicles	Unmanned vehicles, missiles, oil and gas exploration
Cooling		Forced Air 2 CFM	Forced Air 2 CFM	Conduction	Conduction	Conduction
Operating Temperature		0 to +50C	-40 to +85C	-20 to +65C	-40 to +70C	-40 to +85C
Storage Temperature		-20 to +90C	-40 to +100C	-40 to +100C	-40 to +100C	-50 to +100C
Vibration	Sine	-	-	2g 20-500 Hz	5g 20-2000 Hz	10g 20-2000 Hz
	Random	-	-	0.04 g ² /Hz 20-2000 Hz	0.1 g ² /Hz 20-2000 Hz	0.1 g ² /Hz 20-2000 Hz
Shock		-	-	20g, 11 ms	30g, 11 ms	40g, 11 ms
Humidity		0 to 95%, non-condensing	0 to 100%	0 to 100%	0 to 100%	0 to 100%
Conformal coating			Conformal coating	Conformal coating, extended temperature range devices	Conformal coating, extended temperature range devices, Thermal conduction assembly	Conformal coating, extended temperature range devices, Thermal conduction assembly, Epoxy bonding for devices
Testing		Functional, Temperature cycling	Functional, Temperature cycling, Wide temperature testing	Functional, Temperature cycling, Wide temperature testing Vibration, Shock	Functional, Temperature cycling, Wide temperature testing Vibration, Shock	Functional, Testing per MIL-STD-810G for vibration, shock, temperature, humidity

Minimum lot sizes and NRE charges may apply. Contact sales support for pricing and availability.

FMC-250

Standard Features

Analog Input	
Inputs	2
Input Range	+/-1V
Input Type	Single ended, AC or DC coupled
Input Impedance	50 ohm
A/D Device	Intersil ISL216P25 (250MSPS, 16-bit)
A/D Resolution	16-bit
A/D Sample Rate	10 MHz to 250 MHz
Input Bandwidth	300 MHz (-3dB) (AC-Coupled) 250 MHz (-3dB) (DC-Coupled)

Analog Output	
Outputs	2
Output Range	+/-1.0V AC or DC-coupled
Output Type	Single ended, AC or DC coupled
Output Impedance	50 ohm
DAC Device	Analog Devices AD9122BCPZ
DAC Resolution	16-bit
DAC Update Rate	10 MHz to 1200 MHz
Interpolation	None, 2x, 4x
Output Bandwidth	600 MHz (-3dB) AC or DC-Coupled

Clocks and Triggering	
Clock Sources	LMK0480xB PLL or External
	0.3125 to 500 MHz
PLL Reference	External or 10MHz on-card 10MH ref is +/-250ppb -40to +85C
PLL Resolution	80 kHz Tuning Resolution
Phase Noise	-130 dBc @ 100 kHz
Triggering	External, software, acquire N frame
Decimation	1:1 to 1:4095 in FPGA
Channel Clocking	All channels are synchronous
Multi-card Synchronization	External triggering input is used to synchronize sample clocks or an external clock and trigger may be used.

FMC Interface	
IO	LA[33:0] pairs, HA[22:0] pairs, HB[12:0] pairs
IO Standards	LA: LVDS HA: LVDS HB : LVCMOS 1.2V to 3.3V
Required voltages	3.3V, 3.3V AUX VADJ = 1.2V to 3.3V

Reliability	
MTBF	293,106 Hours

FMC-250

Power	
Consumption	6W total 3.3V @ 1.7A 3.3V AUX @ 0.05A VADJ @ 0.1A
Heat Sinking	Conduction cooling supported (VITA20 subset)
Physicals	
Form Factor	FMC VITA 57.1 single-width
Size	76.5 x 69 mm 10 mm mounting height
Weight	100g
Hazardous Materials	Lead-free and RoHS compliant

FMC-250

ELECTRICAL CHARACTERISTICS

Over recommended operating free-air temperature range at 0°C to +60°C, unless otherwise noted.

Parameter	Typ	Units	Notes
A/D Channels			
Analog Input Bandwidth	250	MHz	-3dB, DC coupled inputs
	300	MHz	-3dB, AC coupled inputs
Analog Input Passband Flatness	0.5	dB	0 to 125 MHz, DC Coupled
	0.4	dB	0 to 125 MHz, AC Coupled
Broadband SFDR	82.2	dB	Fin = 5.1 MHz, 95% FS, sine sampled at 250 MSPS; Broadband DC to 125 MHz, AC Coupled
	80.2	dB	Fin = 70.1 MHz, 95% FS, sine sampled at 250 MSPS; Broadband DC to 125 MHz, AC Coupled
SFDR, 70 MHz carrier +/-5 MHz band	91	dB	Fin = 70 MHz, 95% FS, sine sampled at 250 MSPS; Broadband DC to 200 MHz, DC Coupled
Harmonic Distortion	-79	dB	Fin = 70 MHz, 95% FS, sine sampled at 250 MSPS;
	-67	dB	Fin = 125 MHz, 95% FS, sine sampled at 250 MSPS;
ENOB	11.8	bits	Fin = 5.1 MHz, 95% FS, sine sampled at 250 MSPS; Broadband DC to 125 MHz, AC Coupled
	11.5	bits	Fin = 70 MHz, 95% FS, sine sampled at 250 MSPS; Broadband DC to 125 MHz, AC Coupled
SNR	73.3	dB	Fin = 5.1 MHz, 95% FS, sine sampled at 250 MSPS; AC Coupled
	71.7	dB	Fin = 70 MHz, 95% FS, sine sampled at 250 MSPS; AC Coupled
Crosstalk	< -90	dB	Measured channel grounded with a 70.5 MHz, 95% FS sine input on other channel
Noise Floor	-120	dB	Fin = 70.1 MHz, -4dBFS, sine sampled at 250 MSPS, AC coupled
Offset Error	700	μV	Factory calibration, average of 64K samples after warmup.
Gain Error	<0.5	%	Factory calibration after warmup.

FMC-250

ELECTRICAL CHARACTERISTICS

Over recommended operating free-air temperature range at 0°C to +60°C, unless otherwise noted.

Parameter	Typ	Units	Notes
DAC Channels			
Analog Output Range	+/-1000	mV	Typical, AC Coupled
	+/-1000	mV	Typical, DC Coupled
Analog Output Bandwidth	600	MHz	DC Coupled, no sinc compensation
	600	MHz	AC Coupled, no sinc compensation
Output Amplitude Variation	0.7	dB	0-100 MHz, DC Coupled, no sinc compensation
	0.8	dB	1-100 MHz, AC Coupled, no sinc compensation
SFDR	68	dB	20 MHz sine output, 1.2 dBm, DC coupled
	70	dB	20 MHz sine output, 1.2 dBm, AC coupled
S/N	59.7	dB	70.1 MHz sine output, -6 dBfs, AC coupled
	58	dB	70.1 MHz sine output, -6 dBfs, DC coupled
THD	-62	dB	70.1 MHz sine output, -6 dBfs, AC coupled
	-49	dB	70.1 MHz sine output, -6 dBfs, DC coupled
Intermodulation Distortion	<-75	dB	70+/-0.1 MHz, -6dBfs, AC Coupled
Channel Crosstalk	<-85	dB	Aggressor = 125.1 MHz, -3 dBfs adjacent channel
Noise floor	-100	dB	AC or DC output
Gain Error	<0.5	% of FS	Calibrated
Offset Error	<10	mV	Calibrated

FMC-250

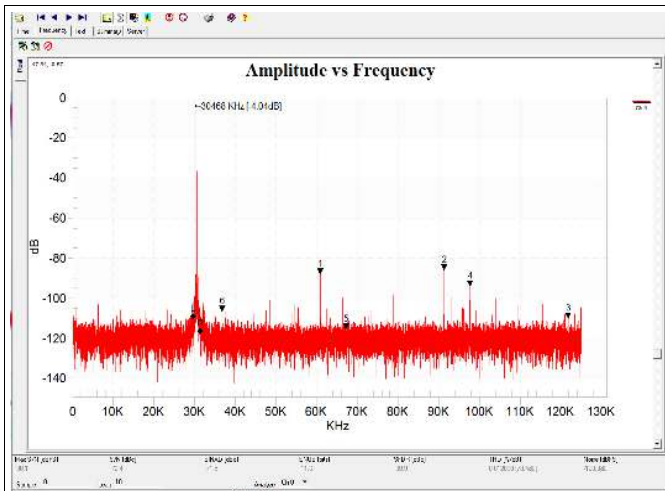

AC-Coupled A/D channel 1 wideband signal quality, $F_{in} = 30.5$ MHz through 7-pole TTE filter, $F_s = 250$ MHz onboard PLL.

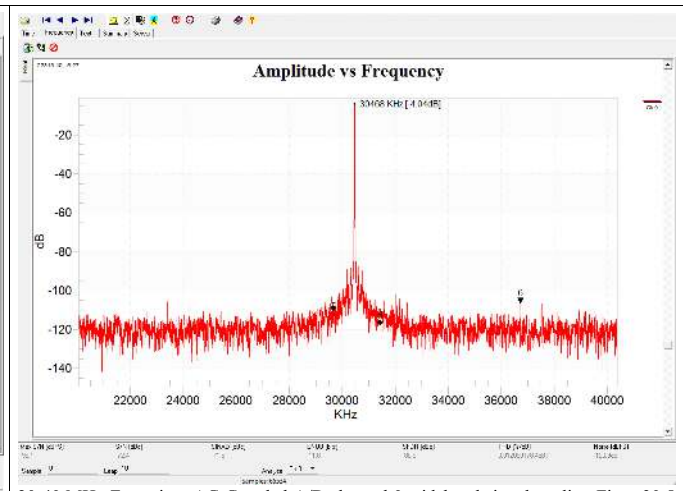

20-40 MHz Zoom into AC-Coupled A/D channel 0 wideband signal quality, $F_{in} = 30.5$ MHz through 7-pole TTE filter, $F_s = 250$ MHz onboard PLL.

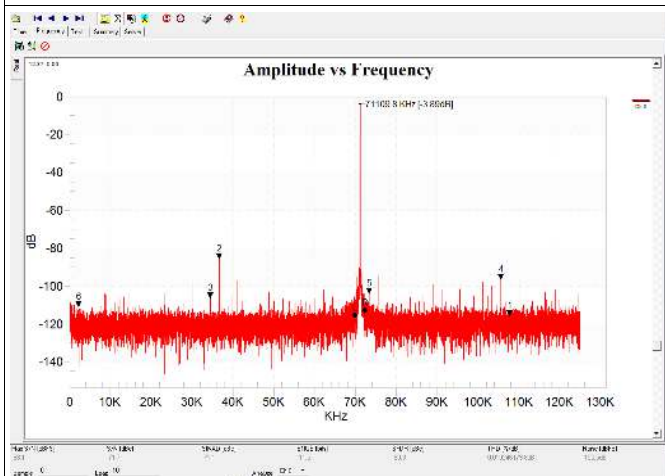

AC-Coupled A/D channel 0 wideband signal quality, $F_{in} = 71.10$ MHz through 7-pole TTE filter, $F_s = 250$ MHz onboard PLL.

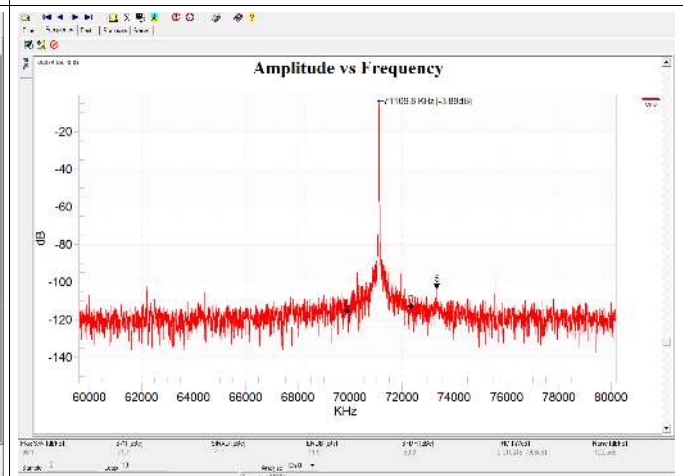

Zoom +/- 5 MHz. AC-Coupled A/D channel 0 narrowband signal quality, $F_{in} = 71.1$ MHz through 7-pole TTE filter, $F_s = 250$ MHz onboard PLL.

FMC-250

DC-Coupled A/D ENOB vs Frequency. Fs = 250 MHz onboard PLL.	DC-Coupled A/D SNR vs Frequency. Fs = 250 MHz onboard PLL.
DC-Coupled A/D SFDR vs Frequency. Fs = 250 MHz onboard PLL.	DC-Coupled A/D THD vs Frequency. Fs = 250 MHz onboard PLL.
DC-Coupled A/D Frequency Response. Fs = 250 MHz onboard PLL.	

ADC Performance

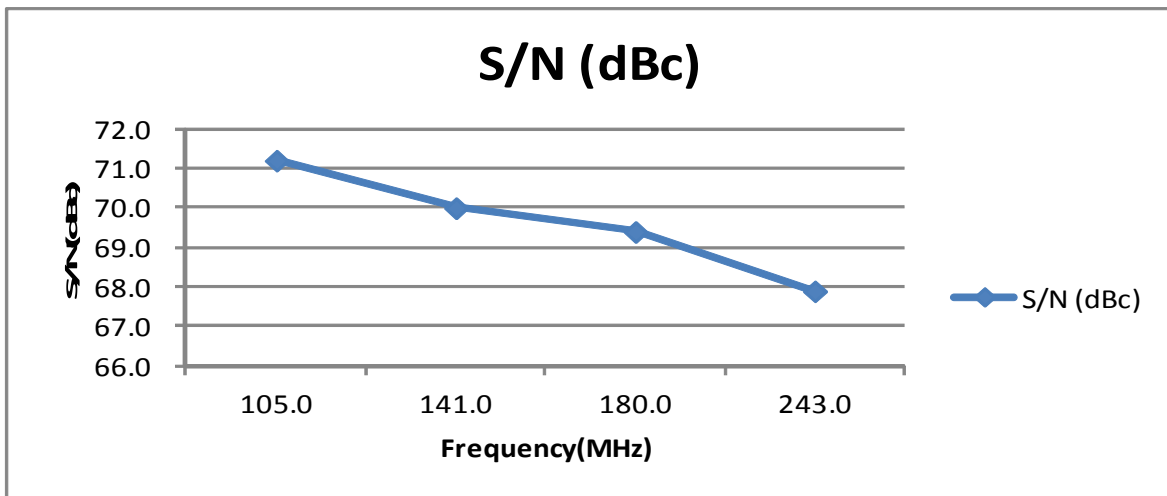

FMC-250

FMC-250

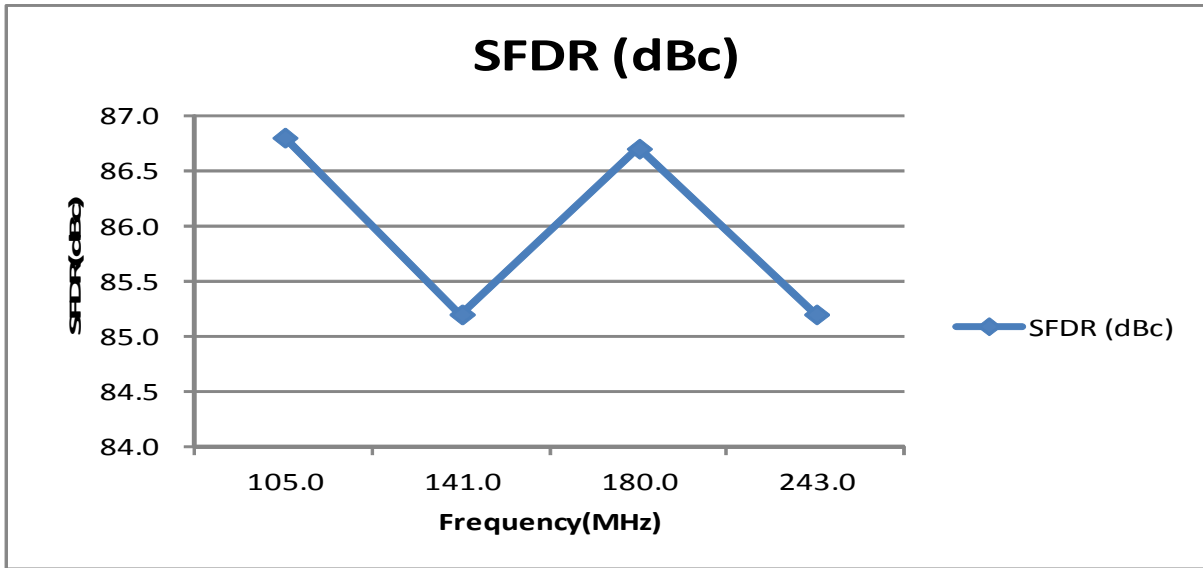

FMC-250

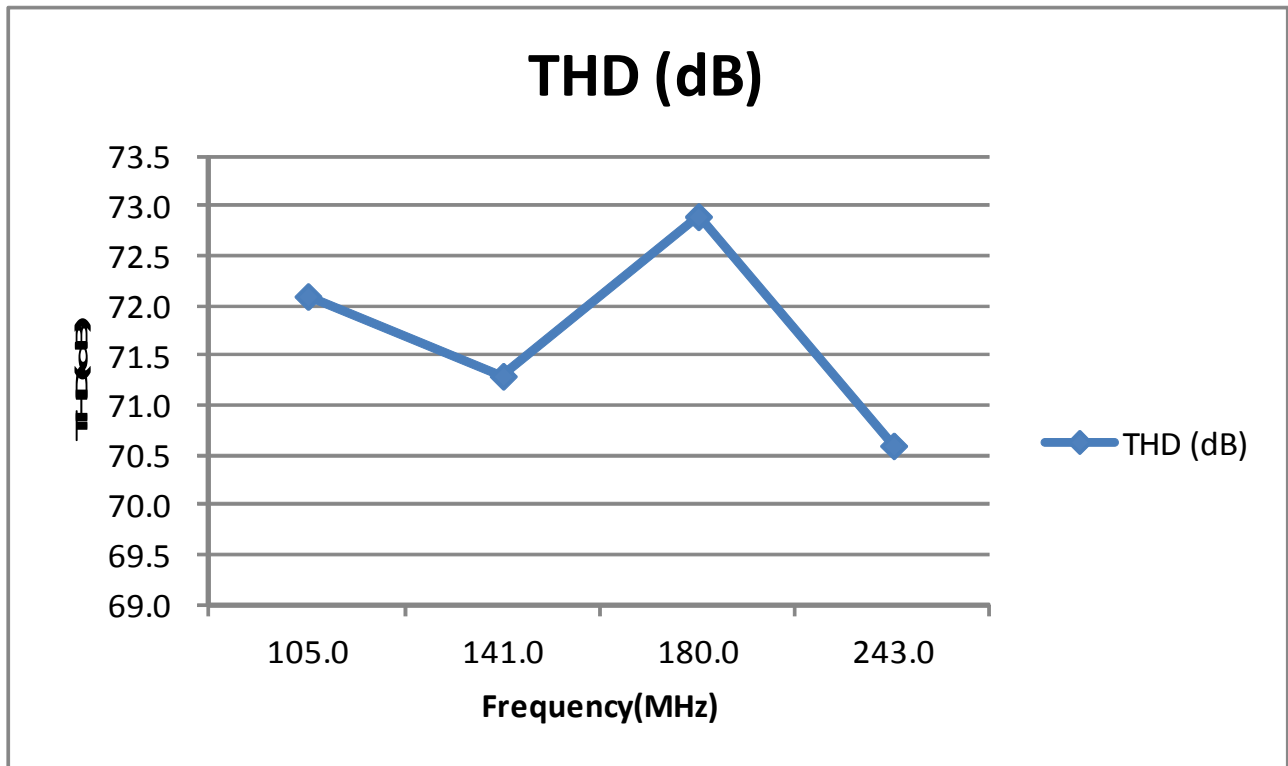
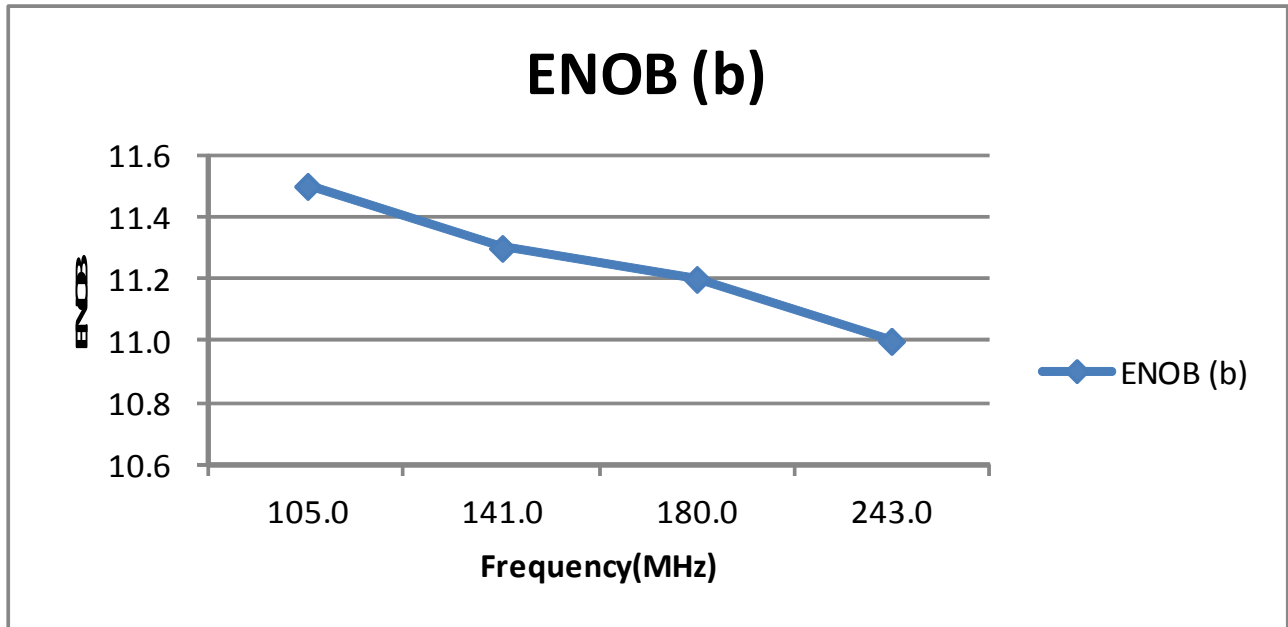

FMC-250

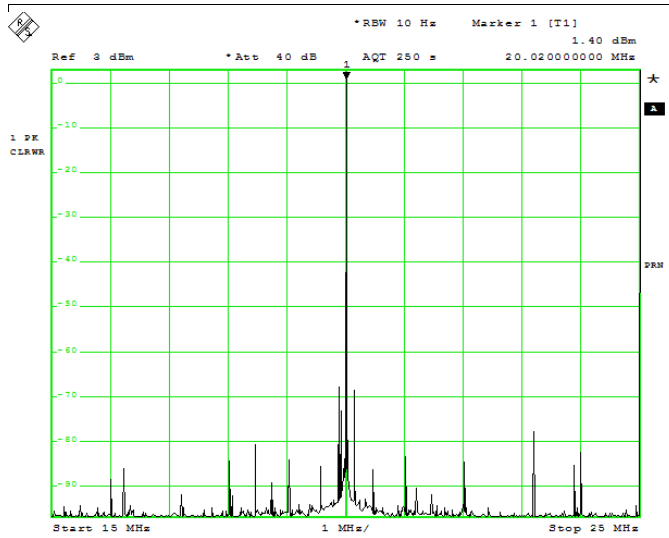

DC-Coupled Output Signal Quality for Fout = 20.0MHz, Fs = 250 MSPS. External clock.

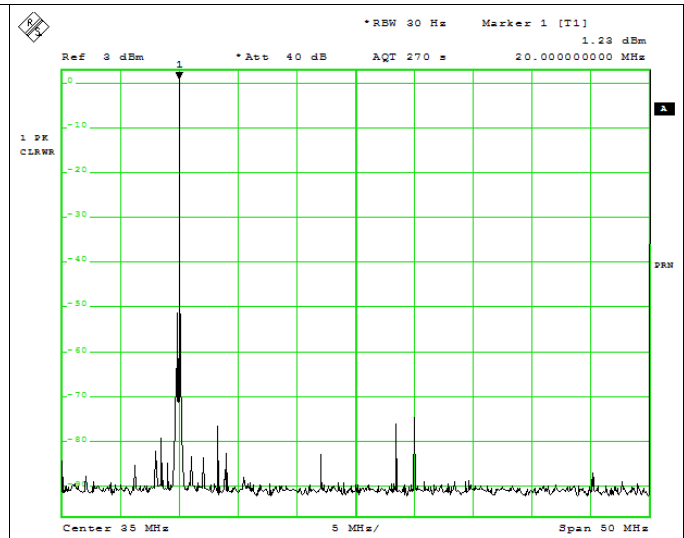

DC-Coupled Output Signal Quality for Fout = 20.0MHz, Fs = 250 MSPS. Internal clock.

FMC-250

IMPORTANT NOTICES

Innovative Integration Incorporated reserves the right to make corrections, modifications, enhancements, improvements, and other changes to its products and services at any time and to discontinue any product or service without notice. Customers should obtain the latest relevant information before placing orders and should verify that such information is current and complete. All products are sold subject to Innovative Integration's terms and conditions of sale supplied at the time of order acknowledgment.

Innovative Integration warrants performance of its hardware products to the specifications applicable at the time of sale in accordance with Innovative Integration's standard warranty. Testing and other quality control techniques are used to the extent Innovative Integration deems necessary to support this warranty. Except where mandated by government requirements, testing of all parameters of each product is not necessarily performed.

Innovative Integration assumes no liability for applications assistance or customer product design. Customers are responsible for their products and applications using Innovative Integration products. To minimize the risks associated with customer products and applications, customers should provide adequate design and operating safeguards.

Innovative Integration does not warrant or represent that any license, either express or implied, is granted under any Innovative Integration patent right, copyright, mask work right, or other Innovative Integration intellectual property right relating to any combination, machine, or process in which Innovative Integration products or services are used. Information published by Innovative Integration regarding third-party products or services does not constitute a license from Innovative Integration to use such products or services or a warranty or endorsement thereof. Use of such information may require a license from a third party under the patents or other intellectual property of the third party, or a license from Innovative Integration under the patents or other intellectual property of Innovative Integration.

Reproduction of information in Innovative Integration data sheets is permissible only if reproduction is without alteration and is accompanied by all associated warranties, conditions, limitations, and notices. Reproduction of this information with alteration is an unfair and deceptive business practice.

Innovative Integration is not responsible or liable for such altered documentation. Resale of Innovative Integration products or services with statements different from or beyond the parameters stated by Innovative Integration for that product or service voids all express and any implied warranties for the associated Innovative Integration product or service and is an unfair and deceptive business practice. Innovative Integration is not responsible or liable for any such statements.

For further information on Innovative Integration products and support see our web site:

www.innovative-dsp.com

Mailing Address: Innovative Integration, Inc.

2390A Ward Avenue, Simi Valley, California 93065

Copyright ©2007, Innovative Integration, Incorporated

FMC-250